

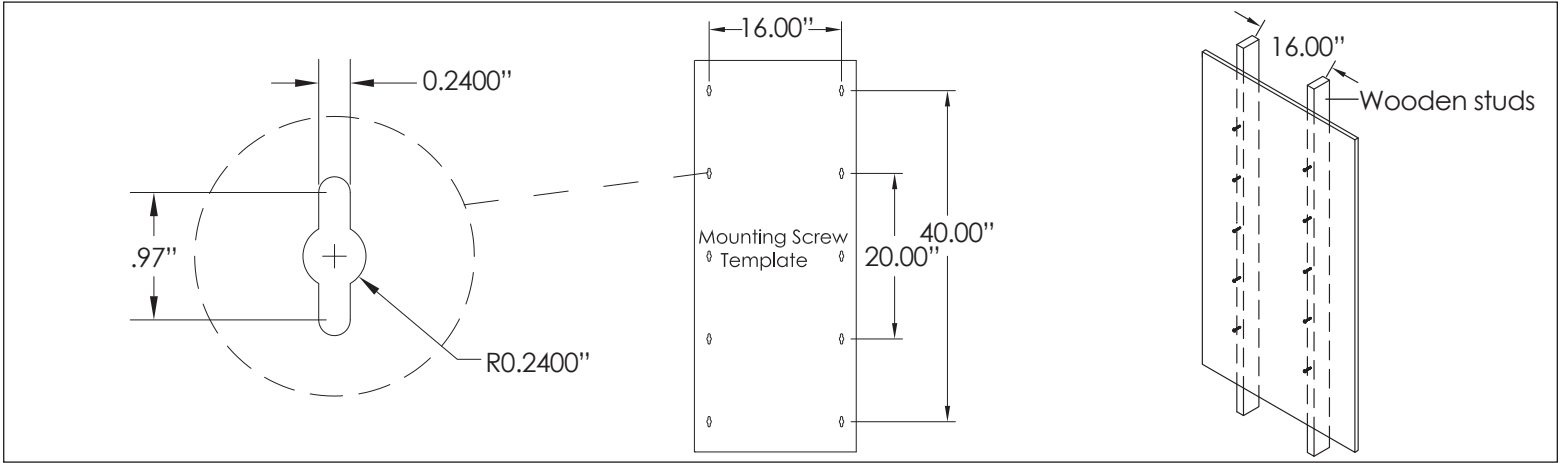

# Swing Frame Wall Mount Rack, 25 RMS

## INSTALLATION INSTRUCTIONS



Step 1: Locate studs, then use the template to mark 10 locations for mounting screws (not provided). Pre-drill the screws without fully tightening them.

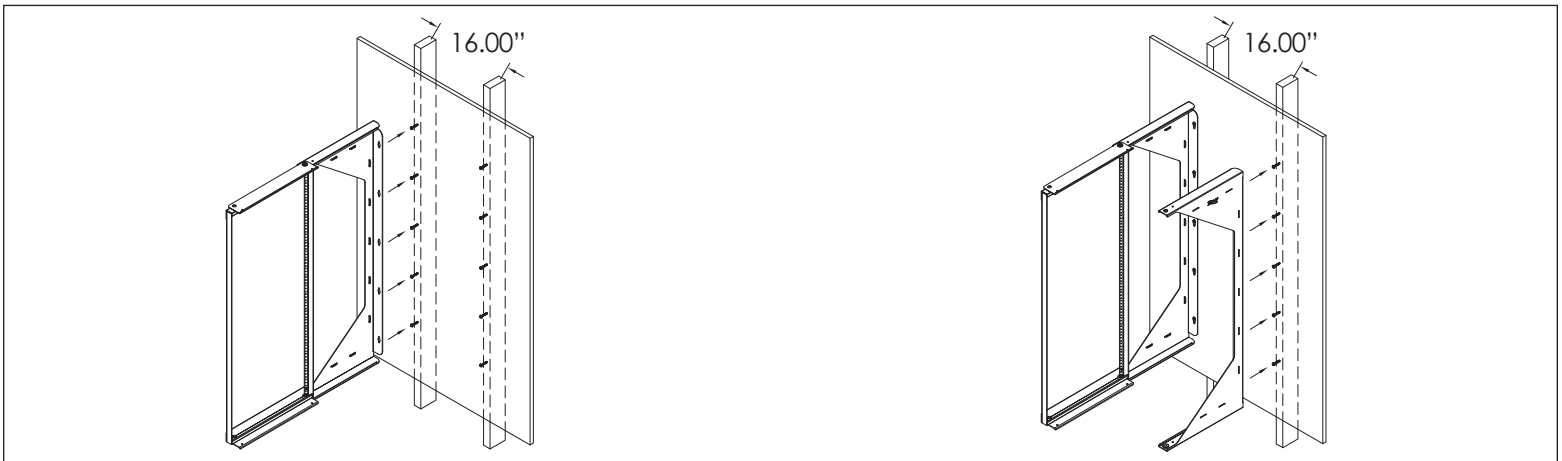

Step 2: Rack can be installed to swing open left or right. Place the left and right brackets onto the pre-drilled screws then tighten all screws.

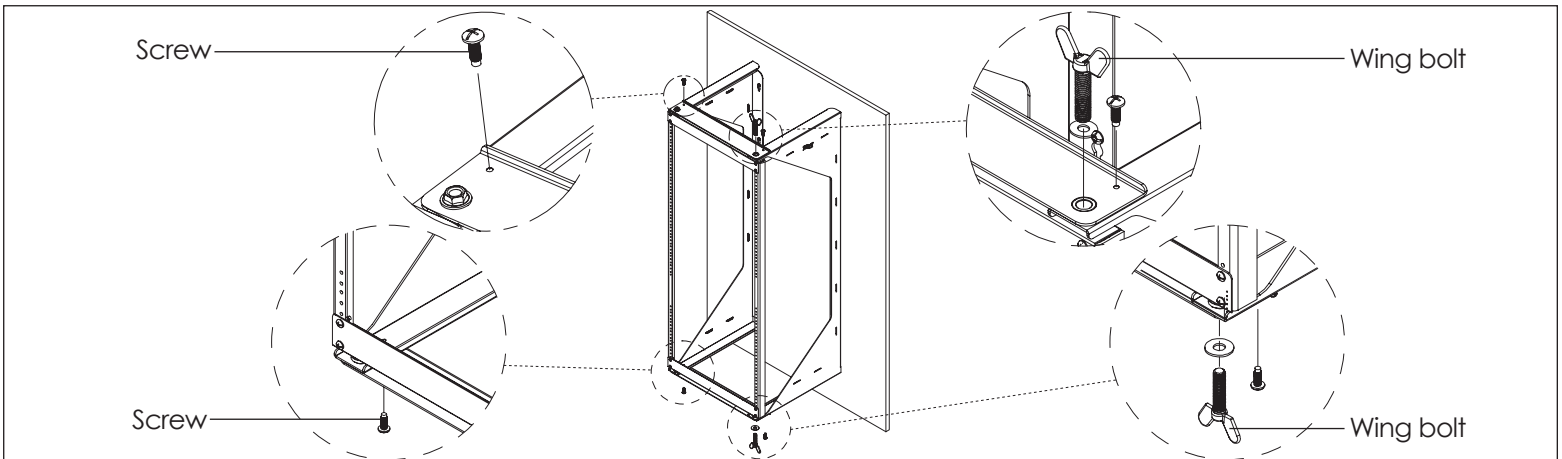

Step 3: Use four #12-24 screws and two wing bolts to secure the top and bottom of the frame to the brackets. **CAUTION!** Please do not exceed more than 85 lbs weight capacity.

# Swing Frame Wall Mount Rack, 25 RMS

## I N S T A L L A T I O N I N S T R U C T I O N S

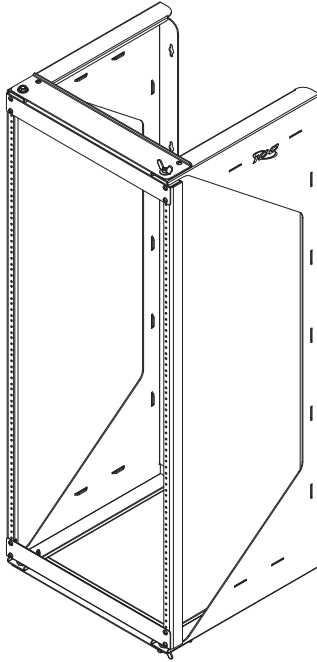

Item #	Dimensions	#12-24 screws
ICCMSSFR25	19.50"W x 49.125"H x 18.00"D	50 screws

## F E A T U R E S A N D B E N E F I T S

- Manufactured with heavy duty steel.
- Supports up to 85 lbs. when properly mounted and fastened.
- Swing out feature allows for easy maintenance and upgrades.
- Rack can be installed to swing open left or right.

## O P T I O N A L A C C E S S O R I E S

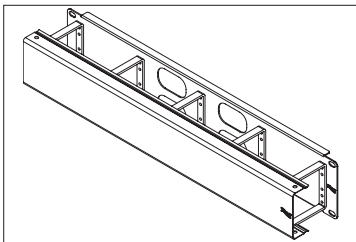

### Metal Ring Panels

**ICCMSCMPK1** Panel with cover, 1 RMS

**ICCMSCMPK2** Panel with cover, 2 RMS

- For horizontal cable routing

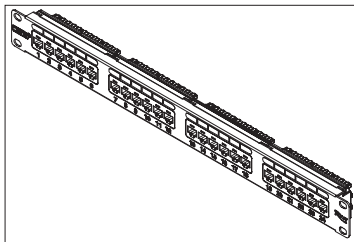

### Patch Panels

**ICMPP0245E** CAT 5e 24-Port, 8P8C, 1 RMS

**ICMPP0485E** CAT 5e 48-Port, 8P8C, 2 RMS

**ICMPP02460** CAT 6 24-Port, 8P8C, 1 RMS

**ICMPP04860** CAT 6 48-Port, 8P8C, 2 RMS

- Exceeds ANSI/TIA-568 standards
- Rear 110-Type IDC termination

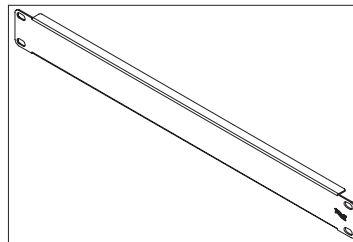

### Blank Panels

**ICCMSCMPB1** 1.75"H x 19"W, 1 RMS

**ICCMSCMPB2** 3.50"H x 19"W, 2 RMS

**ICCMSCMPB3** 5.25"H x 19"W, 3 RMS

**ICCMSCMPB4** 7.00"H x 19"W, 4 RMS

- Fills empty spaces between mounted equipment
- Steel construction for durability

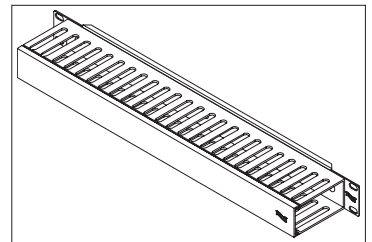

### Single Horizontal Finger Ducts

**ICCMSCMA41** 1.75"H x 3.19"D, 1 RMS

**ICCMSCMA42** 3.50"H x 3.23"D, 2 RMS

- For front cable management
- Durable steel base with plastic fingers
- Includes slide-on cover

1 RMS (Rack Mount Space) = 1.75"

888-ASK-4ICC

csr@icc.com

icc.com