

Available from:

# CablesPlus

U ★ S ★ A

Cables Plus, LLC

8504 Glazebrook Ave Richmond, VA 23228 ~ Toll Free (866) 678-5852

www.CablesPlusUSA.com

## 100-Pair 110 Wiring Block With Feet Kit

### PRODUCT SPECIFICATION

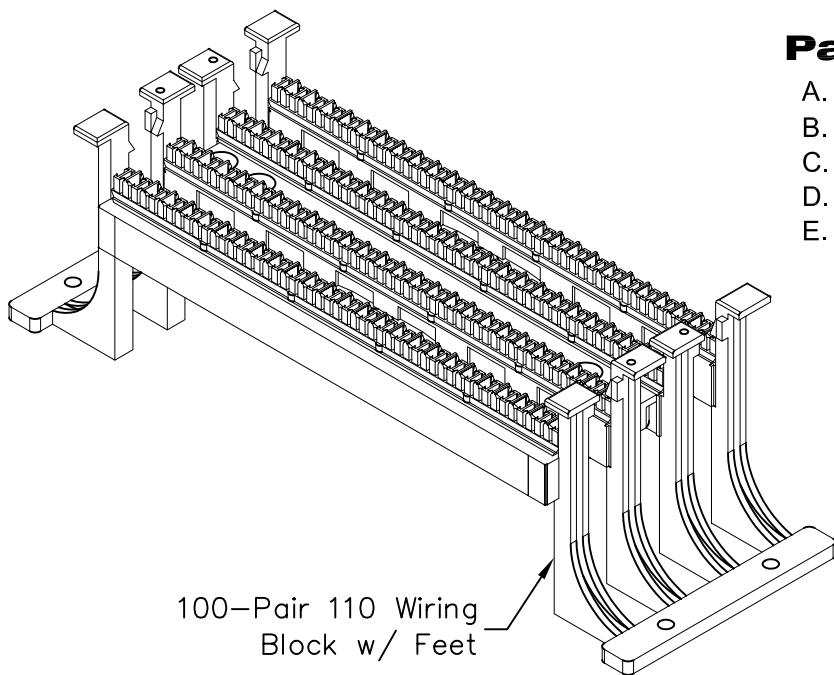

#### Package includes:

- A. 100-Pair 110 Wiring Block w/ Feet, 1 p<sup>C</sup>
- B. 4-Pair 110 Connecting Block, 20 pcs
- C. 5-Pair 110 Connecting Block, 4 pcs
- D. Label Holder, 2 pcs
- E. Designation Label, 2 pcs

20X 4-Pair 110  
Connecting Block



4X 5-Pair 110  
Connecting Block

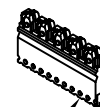

#### Features and Benefits:

- High density wall mounted cross connect system designed for voice and data applications
- Performance exceeds Category 5e connecting hardware requirements specified in TIA/EIA-568-B.2
- Easy system administration with designation labels and label holders
- Used with IC110 cable management blocks, ICACSPDT00 and ICACSPDT05 110 punch down tools
- UL Listed

#### 110 WIRING BLOCK W/ FEET KIT, 100-PAIR

ITEM NO. IC110W1004

REV. A

DWG NO. PS110W1004

PAGE NO. 1

**ICC**  
Premium Products  
Proven Performance  
Competitive Prices

Available from:

# CablesPlus

U ★ S ★ A

Cables Plus, LLC

8504 Glazebrook Ave Richmond, VA 23228 ~ Toll Free (866) 678-5852

www.CablesPlusUSA.com

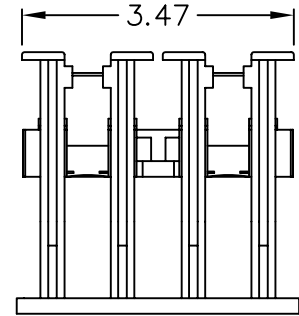
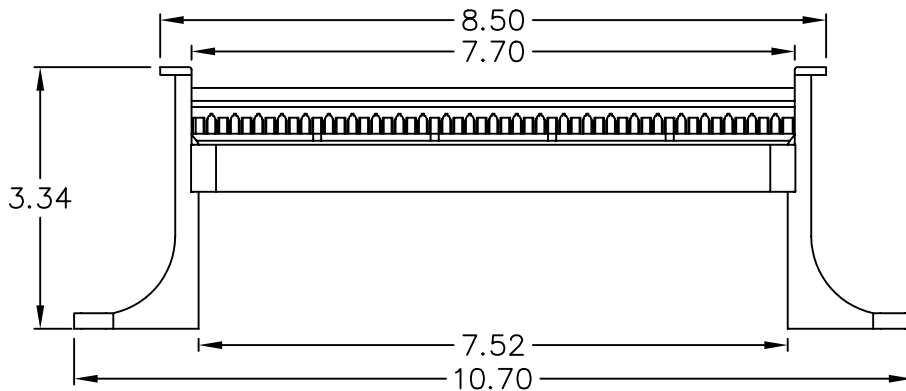
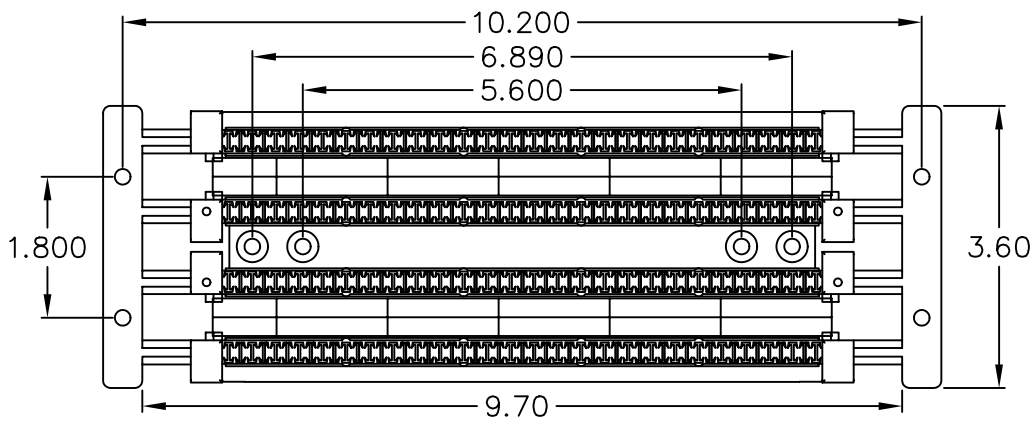

**100-PAIR 110 WIRING BLOCK W/ FEET**

1. MATERIAL: PC, UL 94V-0
2. COLOR: IVORY

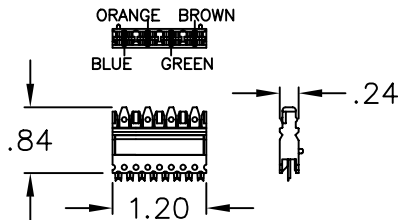

**4-PAIR 110 CONNECTING BLOCK**

1. MATERIAL:
  - A. CONTACT: COPPER ALLOY, 100 MICRO INCHES BRIGHT SOLDER OVER 100 MICRO INCHES OF NICKEL UNDERPLATE
  - B. HOUSING: ABS, UL 94V-0

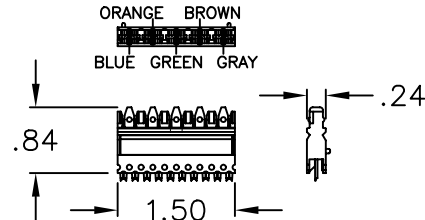

**5-PAIR 110 CONNECTING BLOCK**

1. MATERIAL:
  - A. CONTACT: COPPER ALLOY, 100 MICRO INCHES BRIGHT SOLDER OVER 100 MICRO INCHES OF NICKEL UNDERPLATE
  - B. HOUSING: ABS, UL 94V-0

CAT 5e CONNECTING HARDWARE REQUIREMENTS										
FREQUENCY (MHz)	1.0	4.0	8.0	10.0	16.0	20.0	25.0	31.25	62.5	100
NEXT LOSS (db)	65.0	65.0	64.9	63.0	58.9	57.0	55.0	53.1	47.1	43.0
FEXT LOSS (db)	75.1	63.1	57.0	55.1	51.0	49.1	47.1	45.2	39.2	35.1
RETURN LOSS (db)	35.0	35.0	35.0	35.0	35.0	34.0	32.0	30.1	24.1	20.0
INSERTION LOSS(db)	0.10	0.10	0.10	0.10	0.20	0.20	0.20	0.20	0.30	0.40

**1 10 WIRING BLOCK W/ FEET KIT, 100-PAIR**

ITEM NO. IC110W1004  
 DWG NO. PS110W1004

REV. A  
 PAGE NO. 2

